

SAGIDECK

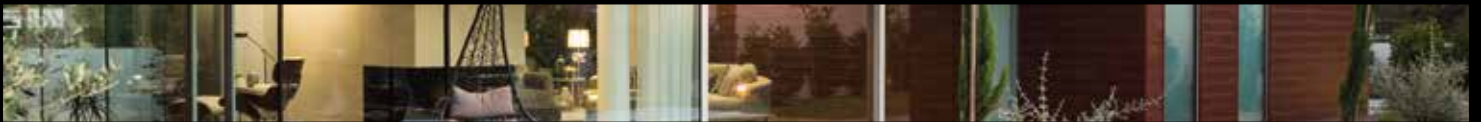

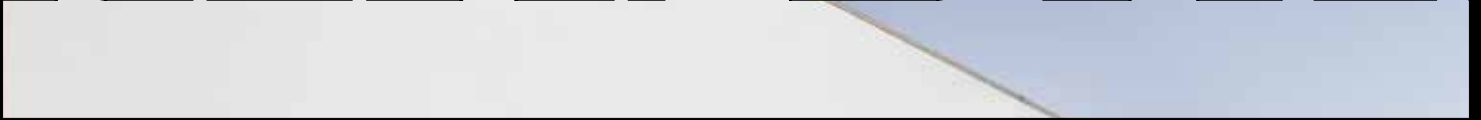

Estilos de vida em harmonia

Lifestyles in harmony

Modes de vie en harmonie

CORES & CONCEITOS . COLOURS & CONCEPTS . COULEURS & CONCEPTS

PT

Com a combinação entre materiais reciclados de madeira com termoplástico, o deck composto Sagiper, apresenta vantagens competitivas em relação ao seu homónimo proveniente da natureza.

EN

With the combination of recycled wood with thermoplastic composite deck Sagiper, presents competitive advantages over its natural counterpart.

FR

Avec la combinaison entre les matériaux recyclés de bois et thermoplastiques, le Deck composite Sagiper, représente des avantages compétitifs en rapport à son origine naturelle.

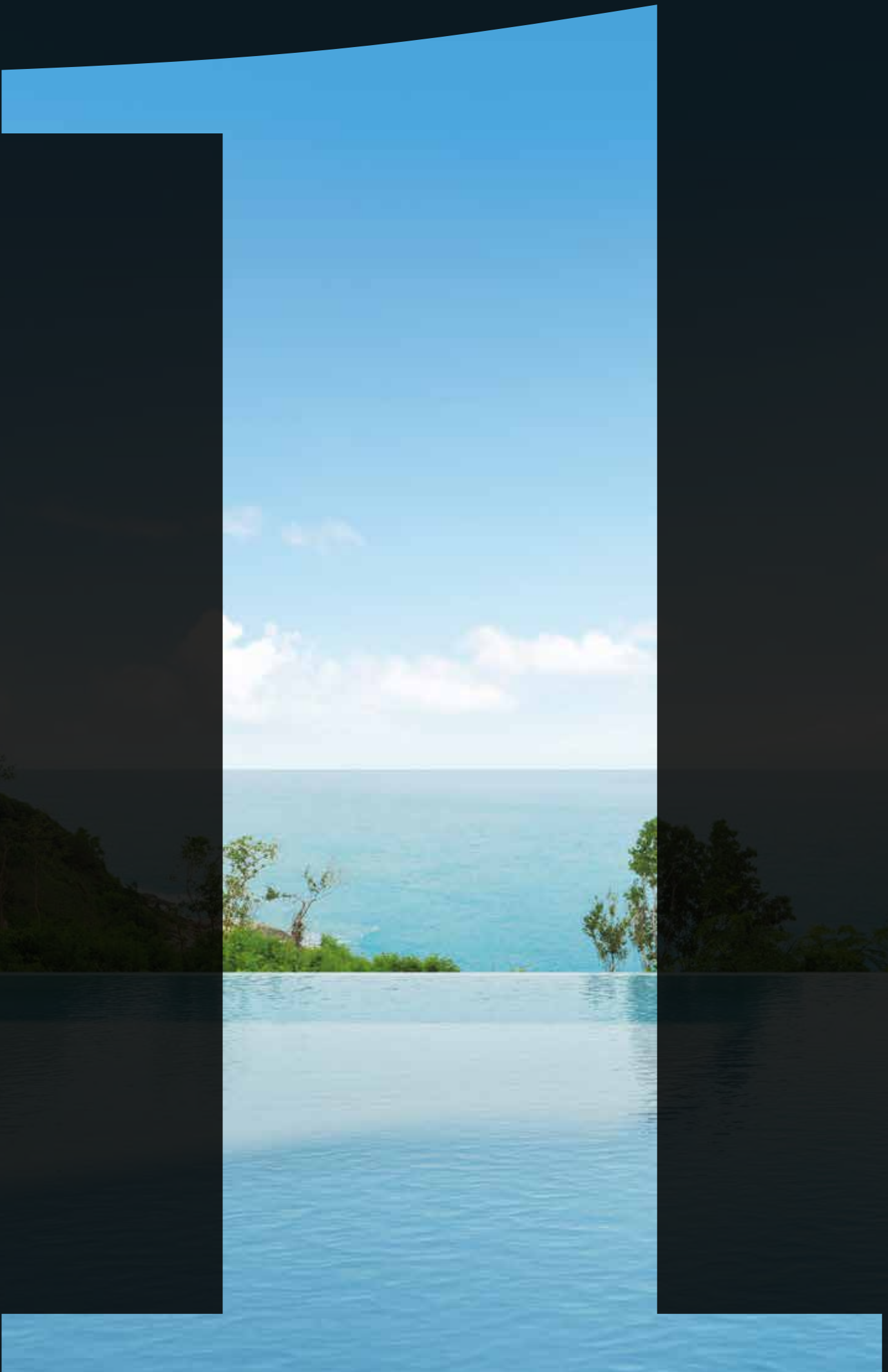



Praia. Cheiro a maresia. Perene mar de sensações.

The beach. The smell of seabreeze. An evergreen sea of sensations.

Plage. Odeur de la mer. Mer pérenne de sensations.







Montanha. Momentos únicos em harmonia plena.

Mountain. Unique moments in pure harmony.

Montagne. Des moments uniques en harmonie.

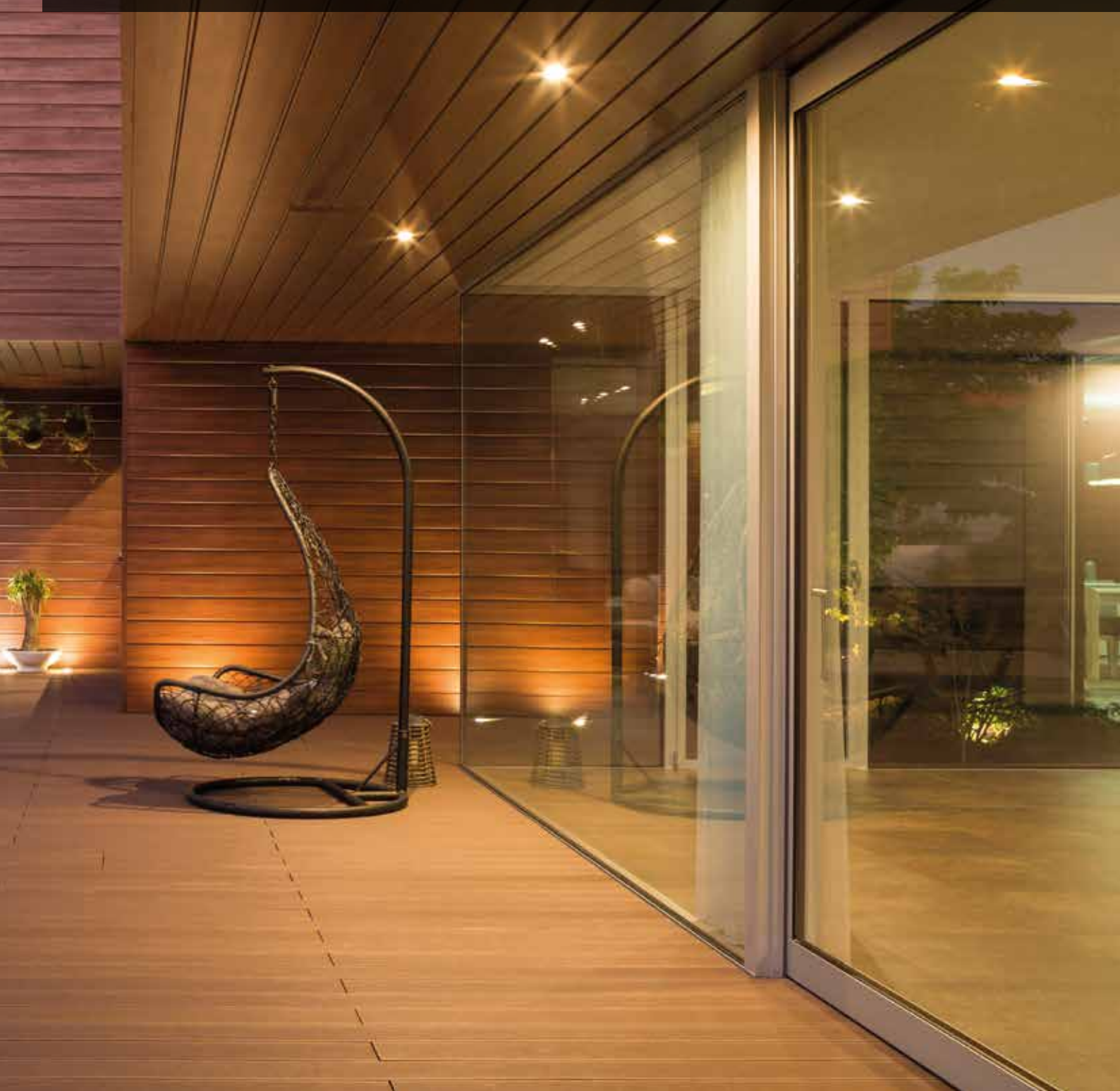







A photograph of an outdoor dining set on a deck. The set includes a square table and four chairs, all made of a light-colored, woven material. The deck is made of dark, horizontal wooden planks. In the background, there is a large glass door or window that reflects the interior of a building. The lighting is bright, suggesting a sunny day.

Cidade. Escapes ritmados de bem-estar.

The city. Rhythmic getaways full of well-being.

Ville. Échappe bien rythmée.





SAGIDECK

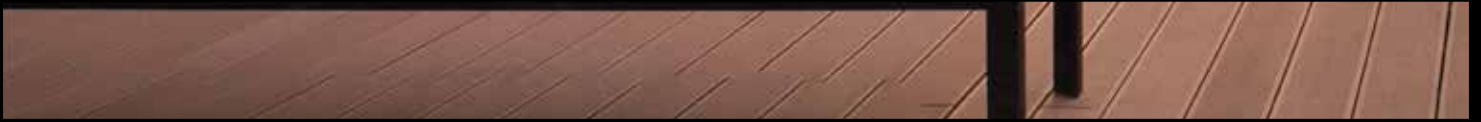



Ficha Técnica

Datasheet

Fiche Technique

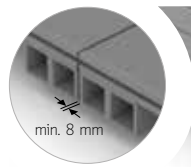
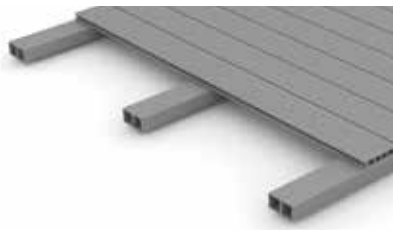
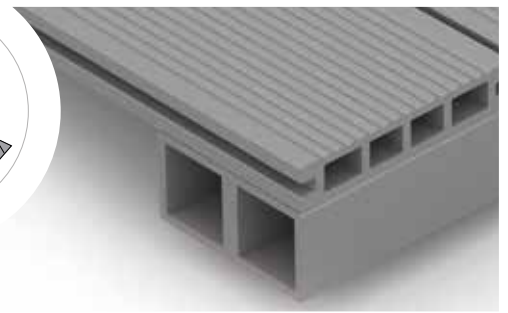
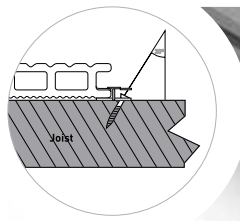
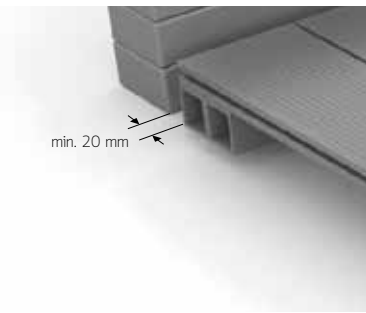
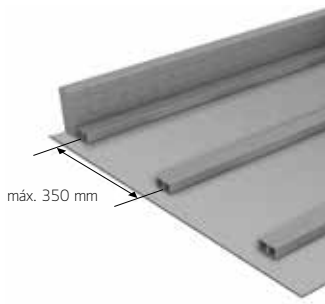



TESTES • TESTS			
COEFICIENTE DE EXPANSÃO LINEAR TÉRMICA EN 15534-1:2014 SECTION 9.2 COEFFICIENT OF LINEAR THERMAL EXPANSION EN 15534-1:2014 SECTION 9.2 COEFFICIENT LINÉAIRE DE DILATATION THERMIQUE EN 15534-1:2014 SECTION 9.2	65x10-6 K-1	-	SGS
ABSORÇÃO DE ÁGUA EN 15534-4:2014 SECTION 4.5.5: 28 DIAS DE IMERSÃO, RESULTADO MÉDIA ≤ 7% WATER ASORPTION EN 15534-4:2014 SECTION 4.5.5: 28 DAYS OF IMMERSION MEAN RESULT ≤ 7% ABSORPTION D'EAU EN 15534-4:2014 SECTION 4.5.5: 28 JOURS D'IMMERSION RÉSULTAT MOYEN ≤ 7%	3,47% (Média)	1,36% (Média)	SGS
DENSIDADE ASTM D792-08 DENSITY ASTM D792-08 DENSITÉ ASTM D792-08	1.293g/cm ³	-	SGS
RESISTENCIA A FLEXÃO EN 15534-4:2014 SECTION 4.5.7 BENDING STRENGHT EN 15534-4:2014 SECTION 4.5.7 RÉSISTANCE À LA FLEXION EN 15534-4:2014 SECTION 4.5.7	30,3 Mpa	31,4 MPa	SGS
MÓDULO DE ELASTICIDADE EM FLEXÃO EN 15534-4:2014 SECTION 4.5.7 MODULUS OF ELASTICITY IN BENDING EN 15534-4:2014 SECTION 4.5.7 MODULE D'ÉLASTICITÉ EN FLEXION EN 15534-4:2014 SECTION 4.5.7	2697 MPa	3866MPa	SGS
PROPRIEDADE DE FLEXÃO EN 15534-4:2014 SECTION 4.5.2: -F' MAX ≥ 3300 N - DEFLEXÃO SOB CARGA DE 500N ≤ 2,0 MM FLEXURAL PROPERTIES EN 15534-4:2014 SECTION 4.5.2: -F' MAX ≥ 3300 N - DEFLECTION UNDER A LOAD OF 500N ≤ 2,0MM PROPRIÉTÉ DE FLEXION EN 15534-4:2014 SECTION 4.5.2: -F' MAX ≥ 3300 N - DÉFLEXION SOUS UNE CHARGE DE 500N ≤ 2,0MM	3894 N 0,64 mm	5080 N 0,52 mm	SGS
RESISTÊNCIA AO ESCORREGAMENTO TESTE DO PÊNDULO EN 15534-4:2014 SECTION 4.4: VALOR DO PÊNDULO ≤ 36 SLIP RESISTANCE PENDULUM TEST EN 15534-4:2014 SECTION 4.4: PENDULUM VALUE ≤ 36 RÉSISTANCE AU GLISSAGE TEST DU PENDULE EN 15534-4:2014 SECTION 4.4: VALEUR DU PENDULE ≤ 36	Pendulum value: 63	-	SGS
RESISTENCIA AO IMPACTO EN 15534-4:2014 SECTION 4.5.1 IMPACT RESISTANCE EN 15534-4:2014 SECTION 4.5.1 RÉSISTANCE A L'IMPACT EN 15534-4:2014 SECTION 4.5.1	Sem quebra, profundidade max de dano: 0,12mm	Sem quebra, profundidade max de dano: 0,06mm	SGS
MASSA LINEAR EN 15534-4:2014 SECTION 4.4 LINEAR MASS EN 15534-4:2014 SECTION 4.4 MASSE LINÉAIRE EN 15534-4:2014 SECTION 4.4	2430g/m	4160g/m	SGS
TESTE DO PLANO INCLINADO EN 15534-1:2014 SECTION 6.4.3 INCLINATION PLAN TEST EN 15534-1:2014 SECTION 6.4.3 TEST DU PLAN INCLINÉ EN 15534-1:2014 SECTION 6.4.3	28,7°: Classe C (X≥24°)	-	SGS
TESTE DA ÁGUA FERVIDA EN 15534-4:2014 SECTION 4.5.5 VALOR MÉDIA DE ABSORÇÃO DE ÁGUA ≤ 7% EM PESO BOILING TEST EN 15534-4:2014 SECTION 4.5.5 MEAN VALUE OF WATER ABSORPTION ≤ 7% IN WEIGHT TEST DE L'EAU BOUILLANTE EN 15534-4:2014 SECTION 4.5.5 VALEUR MOYENNE D'ABSORPTION D'EAU ≤ 7% EN POIDS	3,01%(Média)	1,09%(Média)	SGS

PT

CARACTERÍSTICAS TÉCNICAS

- » Aspecto e toque de madeira natural;
- » Fácil aplicação;
- » Elevada resistência aos raios U.V.;
- » Face reversível;
- » Anti-derrapante;
- » Elevada resistência à absorção de água;
- » Reduzida dilatação/ contração;
- » Dispensa manutenção;
- » 100% ecológico e reciclável;
- » 15 anos de garantia.

COMPOSIÇÃO

Compósito de Fibras de Madeira (60%), termoplástico (35%) e aditivos (5%)

EN

TECHNICAL CHARACTERISTICS

- » Look and feel of natural wood;
- » Easy application;
- » High UV resistance;
- » Reversible Face;
- » Anti-slip;
- » High resistance to water absorption;
- » Low expansion/ contraction;
- » No maintenance;
- » 100% recyclable and eco;
- » 15 year warranty.

COMPOSITION

Composite made of wood fiber(60%), thermoplastics(35%) and additives(5%)

FR

CARACTÉRISTIQUES TECHNIQUES

- » Aspect et contact du bois naturel;
- » Application facile;
- » Haute résistance aux UV;
- » Réversible;
- » Antidérapante;
- » Haute résistance à l'absorption de l'eau;
- » Dilatation/ contraction réduit;
- » Pas d'entretien;
- » 100% écologique et recyclable;
- » 15 ans de garantie.

COMPOSITION

Composite de fibres de bois(60%), thermoplastique(35%) et additifs(5%)

SAGIDECK

cores disponíveis • colors available • couleurs disponibles

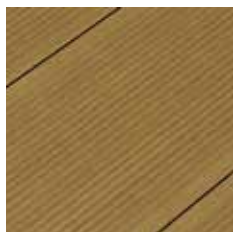

CAMEL 01

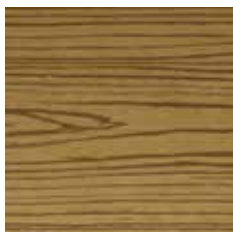

CAMEL 02

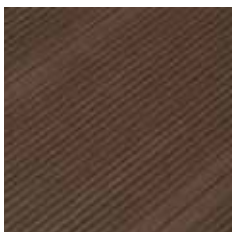

TEKA 01



TEKA 02

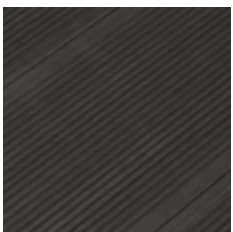

GRANITO 01



GRANITO 02



SAGIDECK maciço • solid • plein
2200 x 135 x 25 mm



SAGIDECK
2200 x 135 x 25 mm

tampa • end cap • capuchon
135 x 25 mm



rodapé • skirting • plinthe
2200 x 55 x 9 mm



sarrafo • keel • lambourde
2200 x 50 x 30 mm



clip em inox
stainless steel clip
clip en inox



clip de arranque em inox
stainless steel start clip
clip de départ en inox



SAGIPER - Produção e comercialização de perfis em PVC, LDA
Zona Industrial de Vagos - Lote 60 - Apt 128 | 3844-909 Vagos - Portugal
T. +351 234 794 214 | +351 234 022 156 | +351 910 952 116
+351 963 497 487 | +351 910 950 307 | • F. +351 234 793 175
www.sagiper.com • sagiper@gmail.com

DISTRIBUIDORES • DISTRIBUTORS • DISTRIBUTEURS

Sagiper North America Inc.
18505 105 Ave NW • Edmonton, AB CANADA T5S 0K3
1-780-482-3445 • Toll Free: 1-866-724-4737 (1-866-SAG-IPER)
www.sagipernorthamerica.com • info@sagipernorthamerica.com

